

LEVEL MONITOR

WITH LINEARISATION, ANALOG AND
HIGH / LOW ALARM OUTPUTS



Features

- Displays level and percentage filled.
- 15 point linearisation of the tank shape - with interpolation.
- Four alarm values can be entered: low-low, low, high and high-high level alarm.
- Large 17mm (0.67") digits.
- Selectable on-screen engineering units; volumetric or mass.
- Operational temperature -30°C up to +80°C (-22°F up to 178°F).
- Very compact design for panel mount, wall mount or field mount applications.
- Rugged aluminum field mount enclosure IP67/NEMA4X.
- Intrinsically Safe
Ex II 1 GD EEx ia IIB/IIC T4 T100°C.
- Explosion/flame proof Ex II 2 GD EEx d IIB T5.
- Alarm and analog signal outputs.
- Full Modbus communication RS232/485/TTL.
- Loop or battery powered, 8 - 24V AC/DC or 115 - 230V AC power supply.
- Sensor supply 3.2 / 8.2 / 12 / 24V DC.

Signal output

- Up to 4 free configurable alarm outputs.
- (0)4 - 20mA / 0 - 10V DC according to the linearised level.

Signal input

Level

- (0)4 - 20mA.
- 0 - 10V DC.

Applications

- Level measurement where linearisation and continuous level monitoring is important. Also re-transmission of the level or serial communication is required. Alternative basic model: F070 - F073 - F077 and F170.

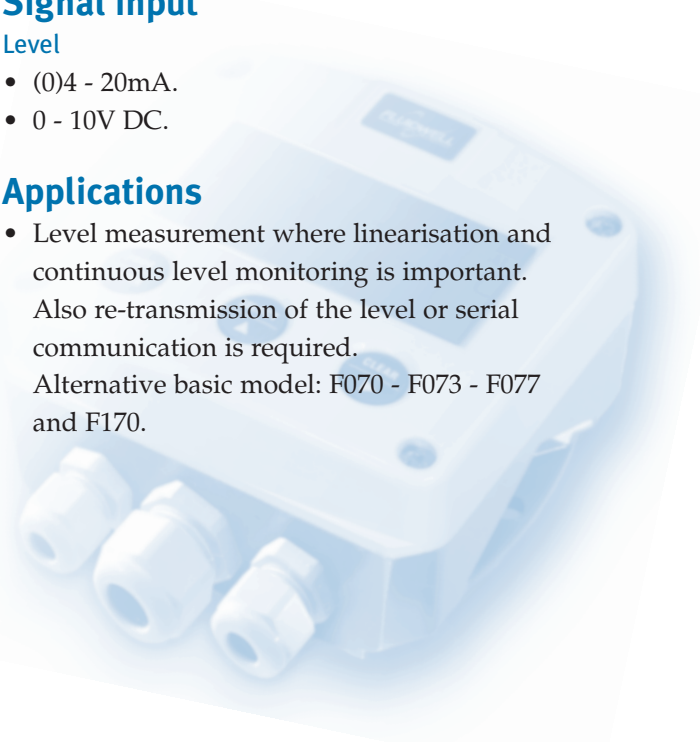

General information

Introduction

The F173 is a versatile level indicator with linearisation and continuous level monitoring feature. It offers the facility to set two low level and two high level alarm values. If desired, an ignore function can be set up to allow for an incorrect level for a certain period of time. Up to four outputs are available to transmit the alarm condition. A wide selection of options further enhance this models capabilities, including Intrinsic Safety and full Modbus communication.

Display

The display has large 17mm (0.67") and 8mm (0.31") digits which can be set to show level, percentage and alarm values.

The alarm values can be password protected. On-screen engineering units are easily configured from a comprehensive selection.

Configuration

All configuration settings are accessed via a simple operator menu which can be pass-code protected. Each setting is clearly indicated with an alphanumerical description, therefore avoiding confusing abbreviations. All settings are safely stored in EEPROM memory in the event of sudden power failure.

Analog output signal

The actual level is re-transmitted with the (0)4 - 20mA or 0 - 10V DC output signal. The output signal is updated ten times per second with a filter function being available to smoothen out the signal if desired. The output value is user defined in relation to the level, e.g. 4mA equals to 5m³ and 20mA equals to 20.000 m³. The output signal can be passive, active or isolated where the passive output type will loop power the F173 as well.

Alarm outputs

Up to four configurable outputs are available to transmit the alarm condition. You can have e.g. two the same low alarm outputs, one high alarm output and one "all alarms" output. Type OS offers four mechanical relay outputs. However, only two outputs are available in Intrinsically Safe applications. Three outputs are available in all other configurations.

The output signals can be a passive NPN, active PNP or an isolated electro-mechanical relay.

Signal input

The F173 does accept (0)4 - 20mA and 0 - 10V input signals from any type of level measurement device. Also a 4 - 20mA input loop powered model is available.

Communication

All process data and settings can be read and modified manually or through the Modbus communication link (RS232 / RS485). Full Modbus functionality remains available for the Intrinsically Safe version (TTL).

Hazardous areas

For hazardous area applications, this model has been ATEX certified Intrinsically Safe $\text{Ex II 1 GD EEx ia IIB / IIC T4 T100}^\circ\text{C}$ with an allowed operational temperature of -30°C to $+70^\circ\text{C}$ (-22°F to $+158^\circ\text{F}$). A flame proof enclosure is also available with the rating $\text{Ex II 2 GD EEx d IIB T5}$.

Enclosures

Various types of enclosures can be selected, all ATEX approved. As standard the F173 is supplied in an GRP panel mount enclosure, which can be converted to an IP67 / NEMA 4X GRP field mount enclosure by the addition of a back case. Most popular is our rugged aluminum field mount enclosure with IP67 / NEMA 4X rating. Both European or U.S. cable gland entry threads are available.

Overview application F173

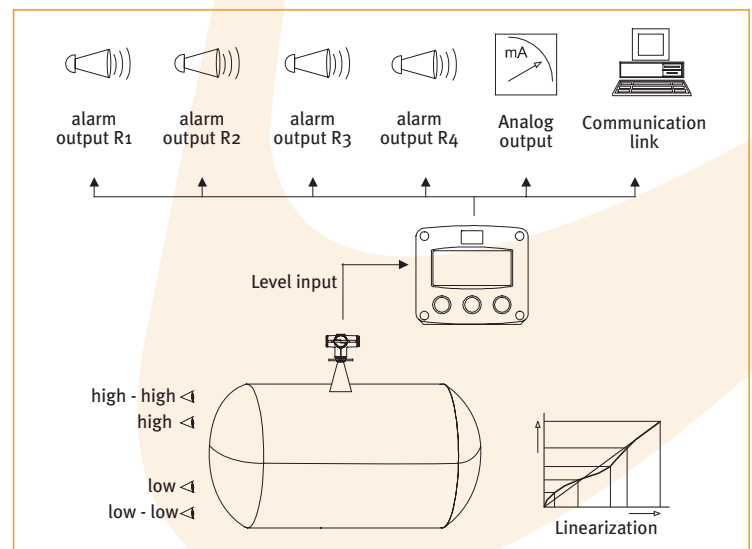

Dimensions enclosures

Aluminum & GRP panel mount enclosure

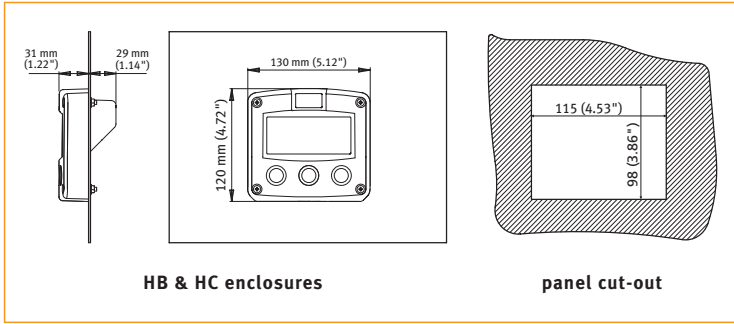

HB & HC enclosures

panel cut-out

Aluminum & GRP field / wall mount enclosures

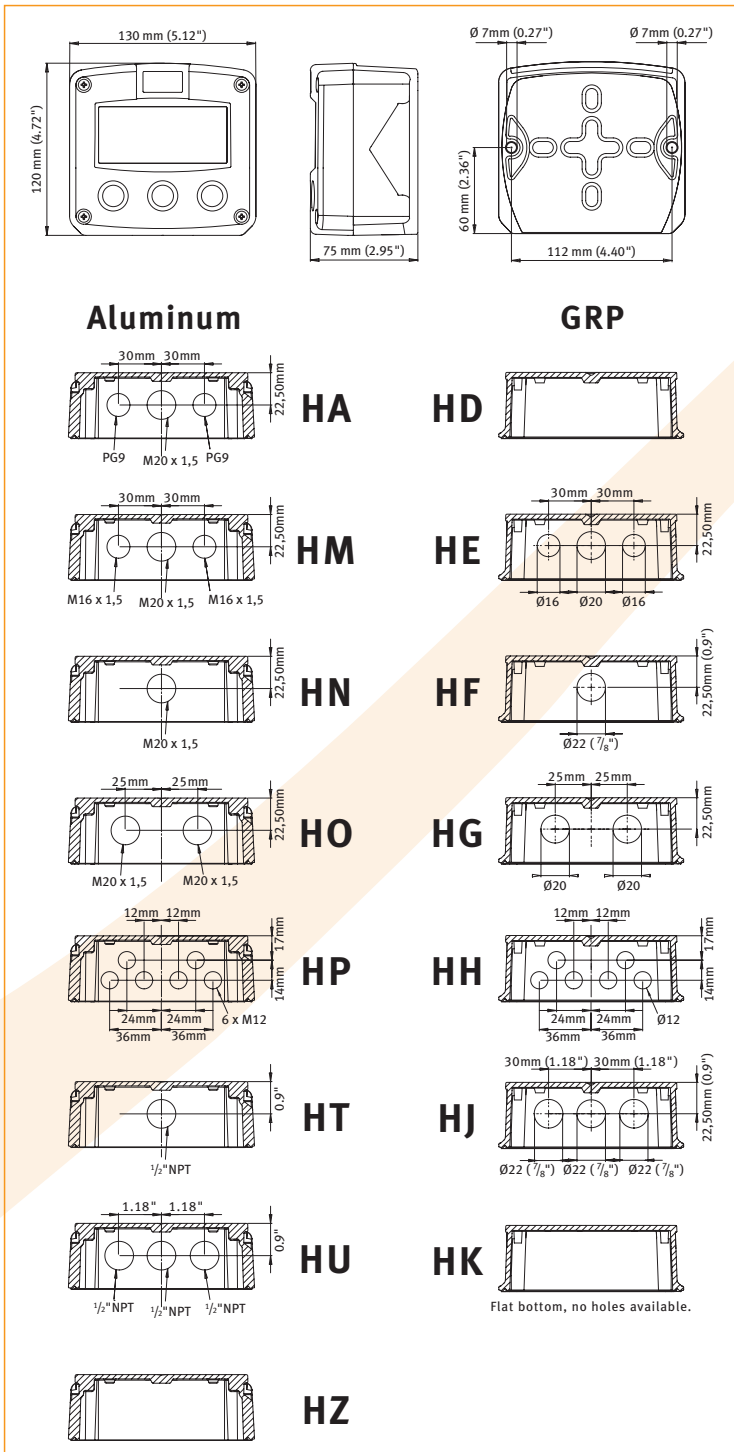

Aluminum

GRP

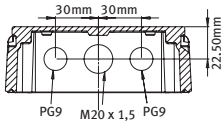

HA

HD

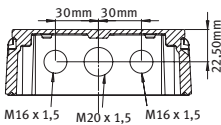
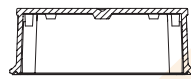

HM

HE

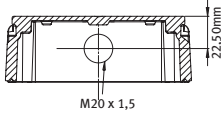
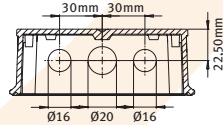

HN

HF

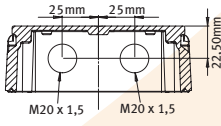
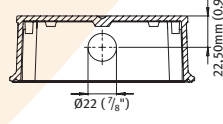

HO

HG

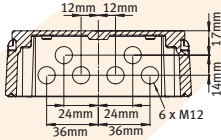
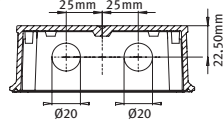

HP

HH

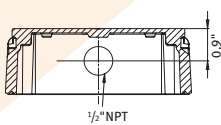
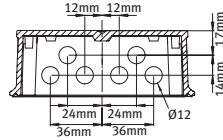

HT

HJ

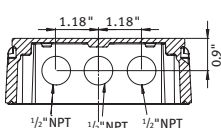
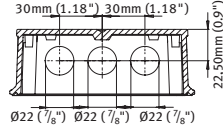

HU

HK

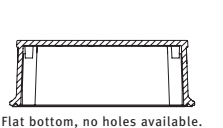

Flat bottom, no holes available.

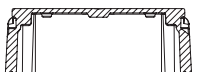

HZ

Terminal connections

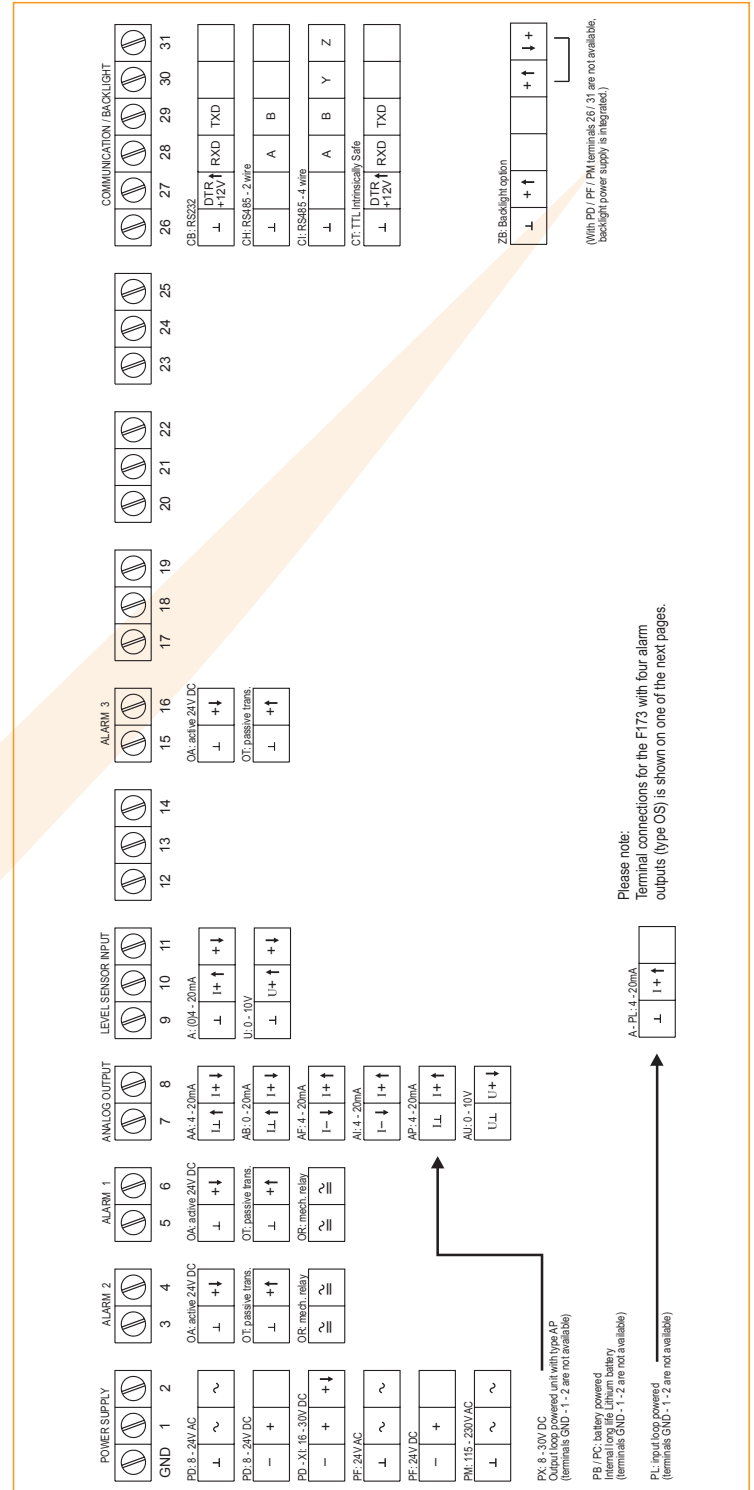

Please note:
Terminal connections for the F173 with four alarm outputs (type OS) is shown on one of the next pages.

Display example - 90 x 40mm (3.5" x 1.6")



Typical wiring diagram F173-A-AP-CH-OT-PX

Typical wiring diagram F173-A-AA-CB-OA-PD

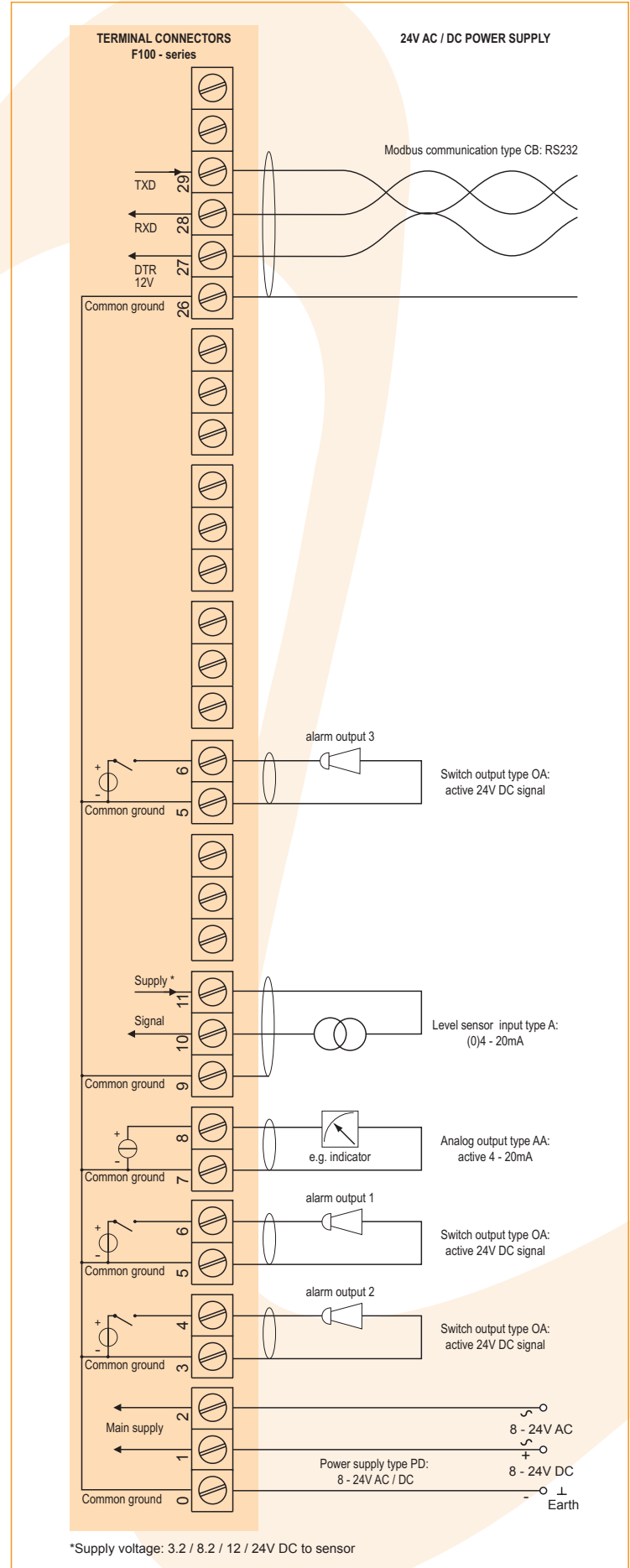
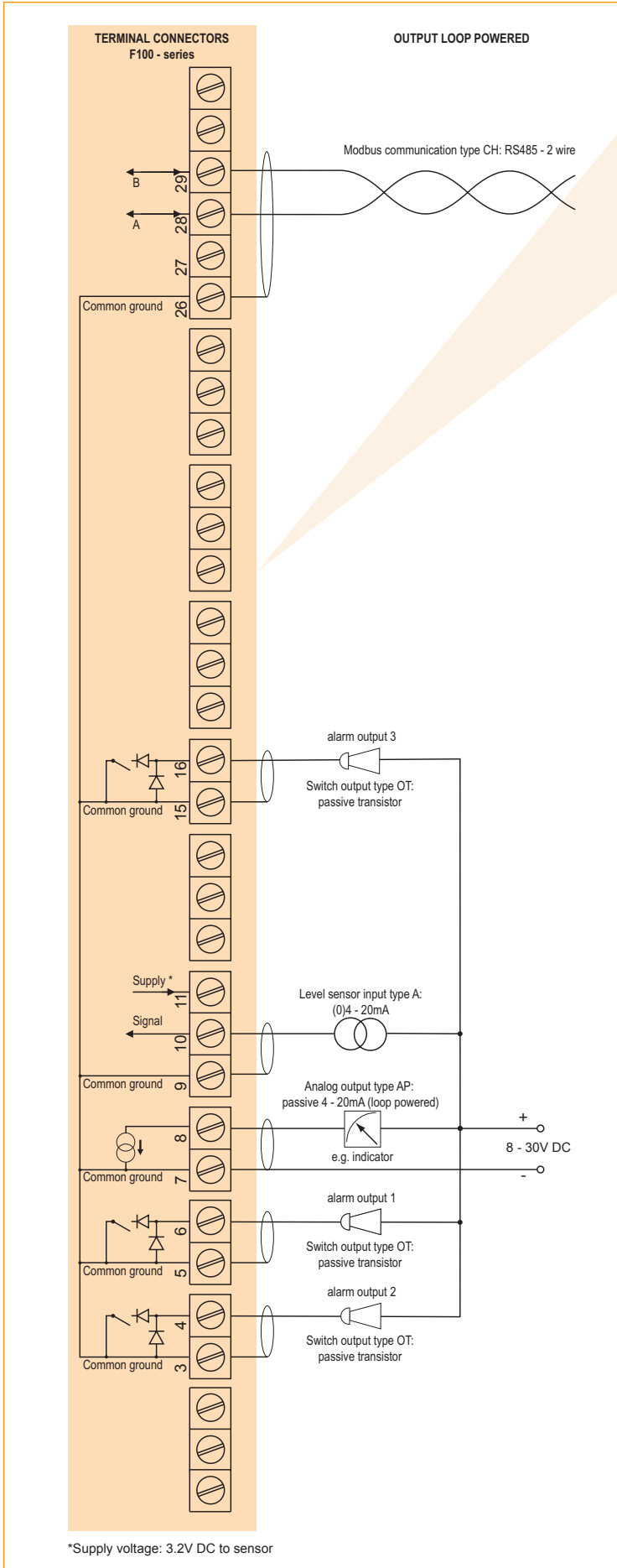

Typical wiring diagram F173-A-AI-CI-OR-PM

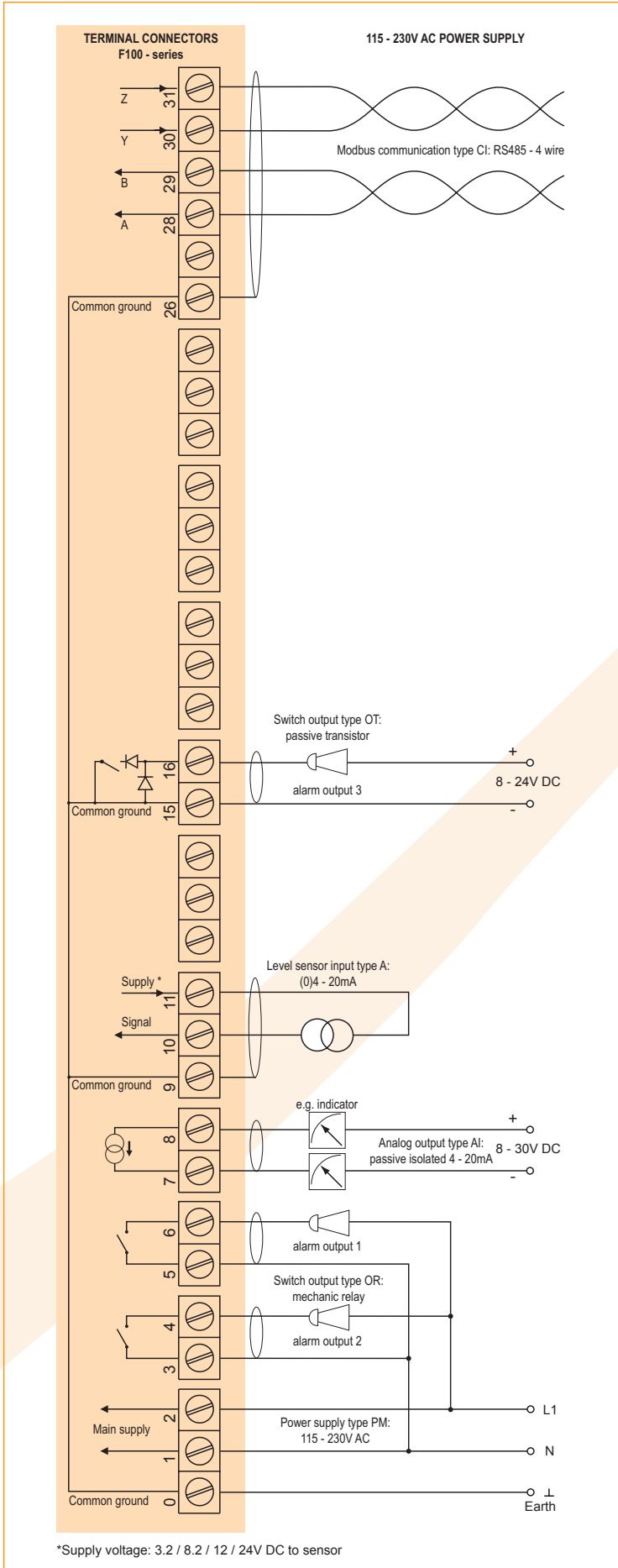

Typical wiring diagram F173-A-AP-CB-OS-PD

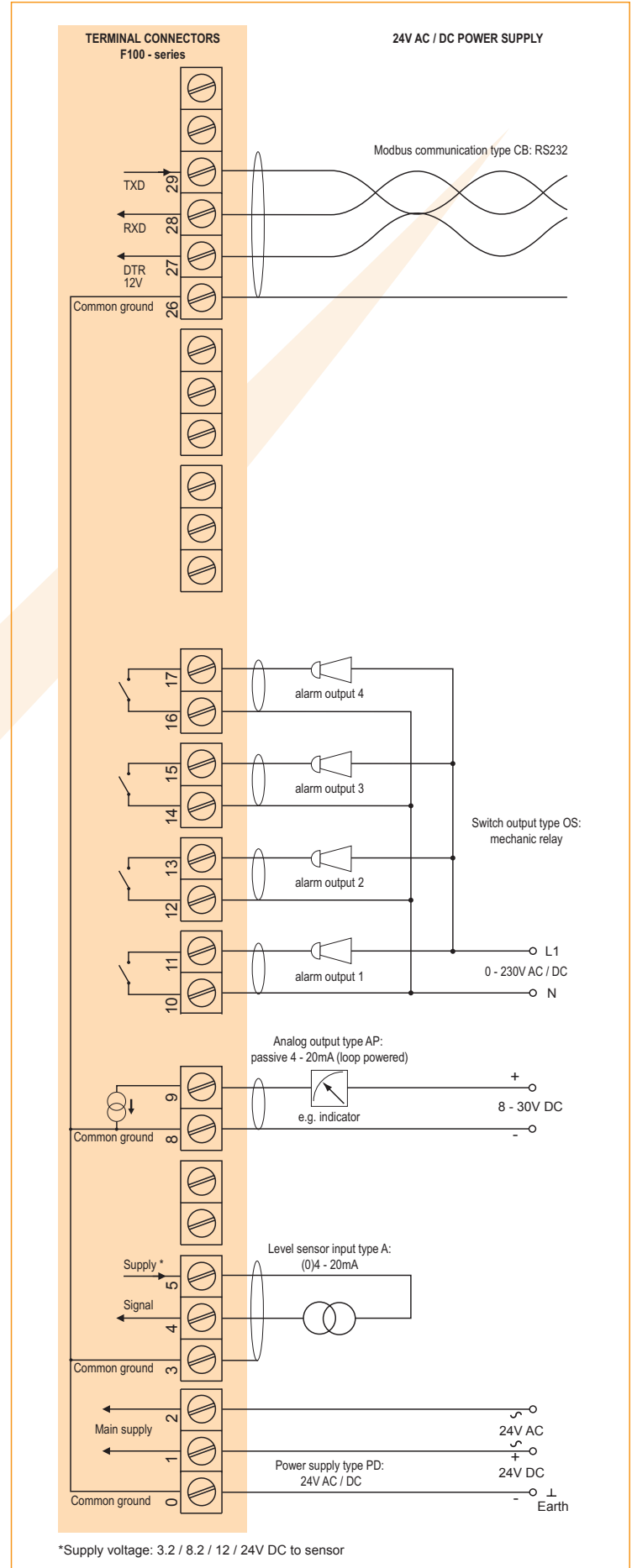

Hazardous area applications

The F173-XI has been ATEX approved by KEMA for use in Intrinsically Safe applications. It is approved according to Ex II 1 GD EEx ia IIB/IIC T4 T100°C for gas and dust applications with an operational temperature range of -30°C to +70°C (-22°F to +158°F). Besides the I.S. power supplies for the two alarm outputs, it is allowed to connect up to three I.S. power supplies in IIB applications or one in IIC applications. Full functionality of the F173 remains available, including two alarm outputs and 4 - 20mA output and Modbus communication (type CT). Power supply type PD-XI offers a sensor supply according to the connected power supply voltage at terminal 1. A flame proof enclosure with rating Ex II 2 GD EEx d IIB T5 is available as well. Please contact your supplier for further details.

Certificate of conformity KEMA 03ATEX1074 X

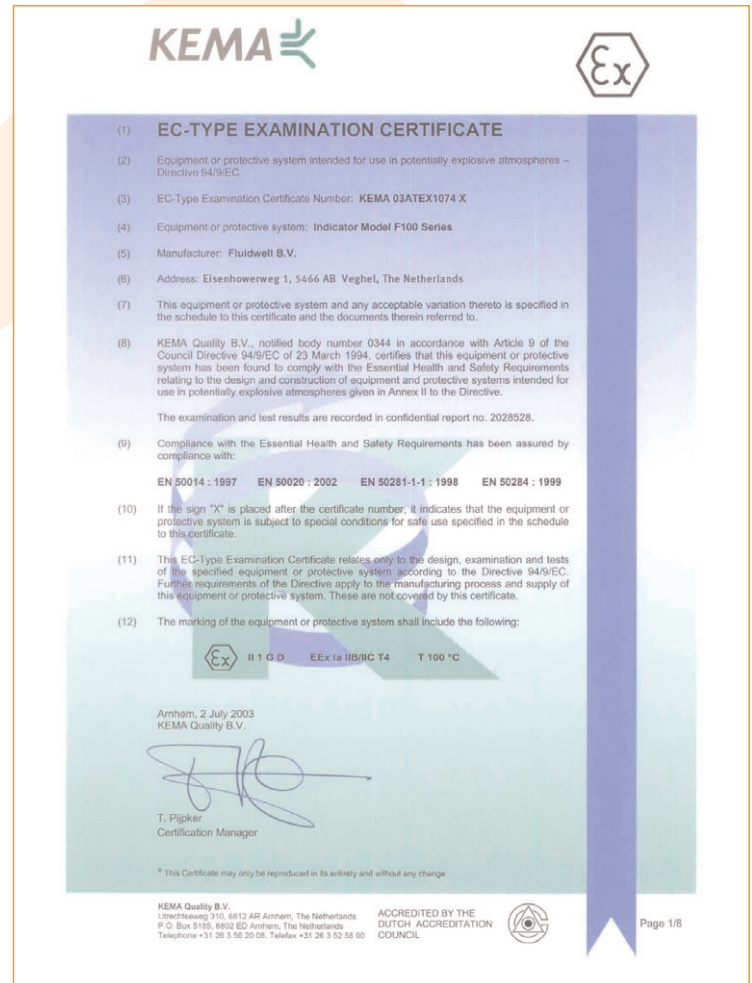

Configuration example IIB

F173-A-AF-CT-OT-PL-XI - Input loop powered unit

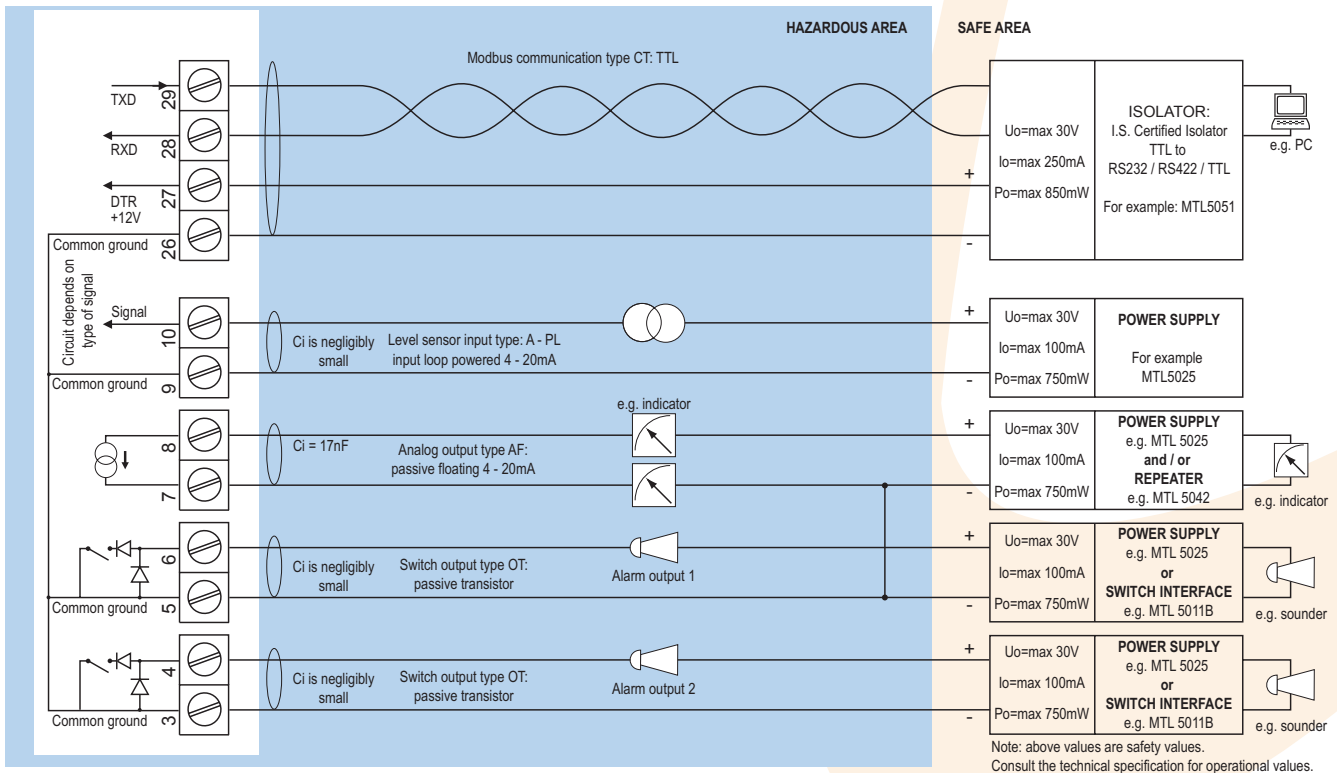

Configuration example IIB - F173-A-AP-CT-OT-PX-XI - Output loop powered

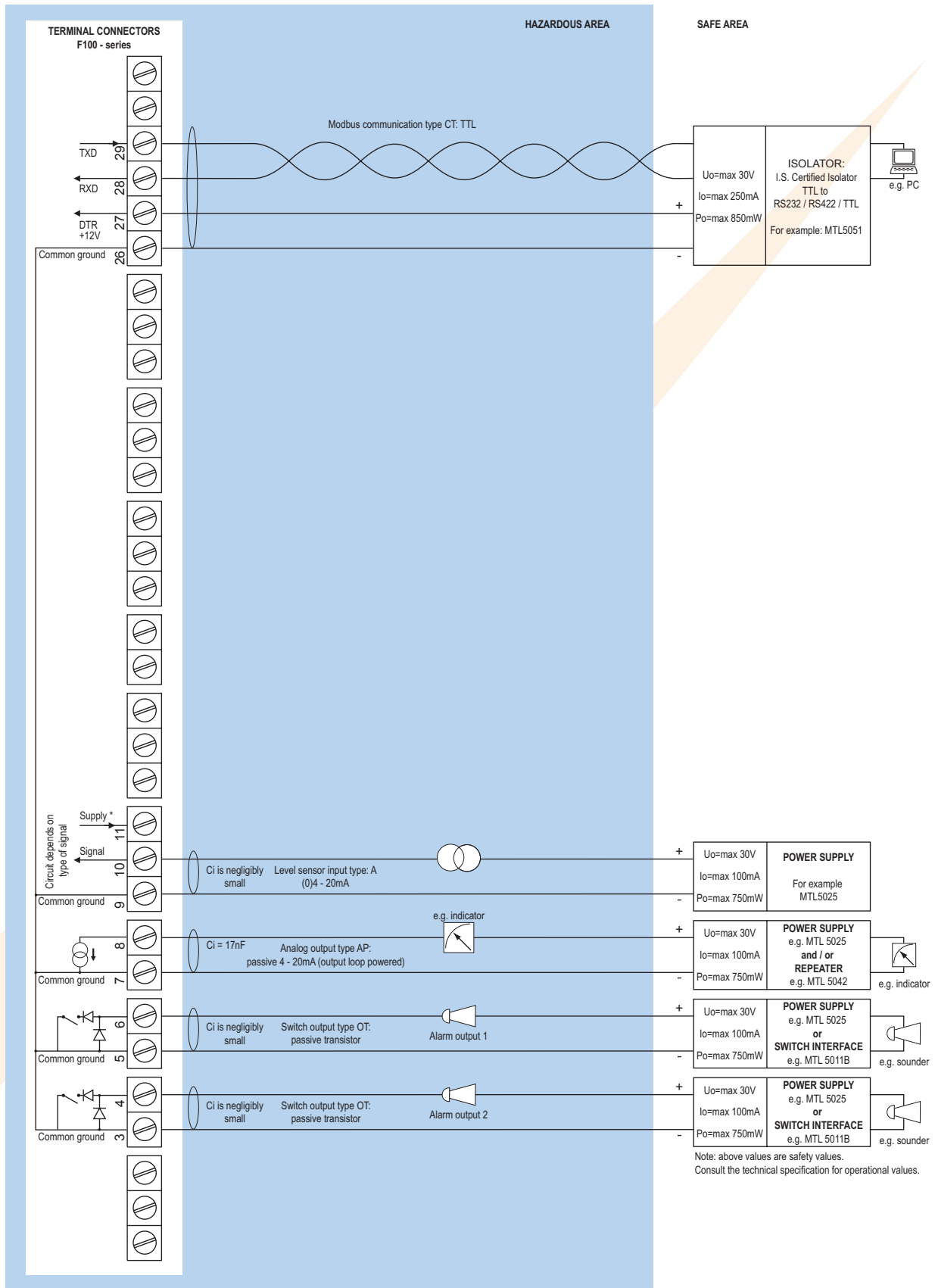

* Note sensor supply voltage: 3.2V DC - not suitable to power analog sensors.

Configuration example IIB and IIC - F173-A-AP-(CT)-OT-PD-XI - Power supply 16 - 30V DC

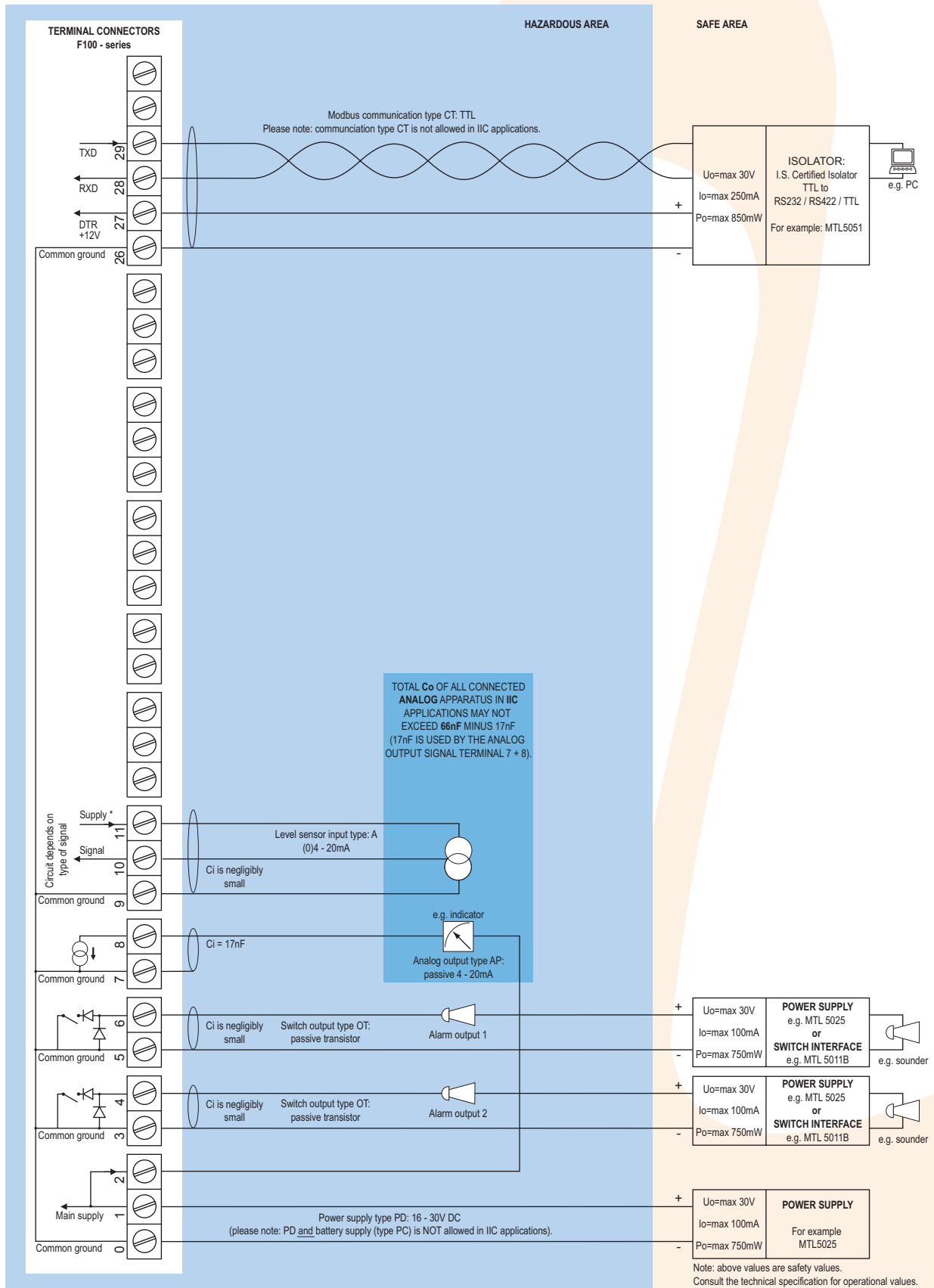

* Note power supply type PD: the supply voltage to the analog sensor is as connected to terminal 1 (internally linked).

Configuration example IIB - F173-A-AF-CT-OT-(PC)-(PD)-(PL)-XI - Power supply 16 - 30V DC, battery or loop powered

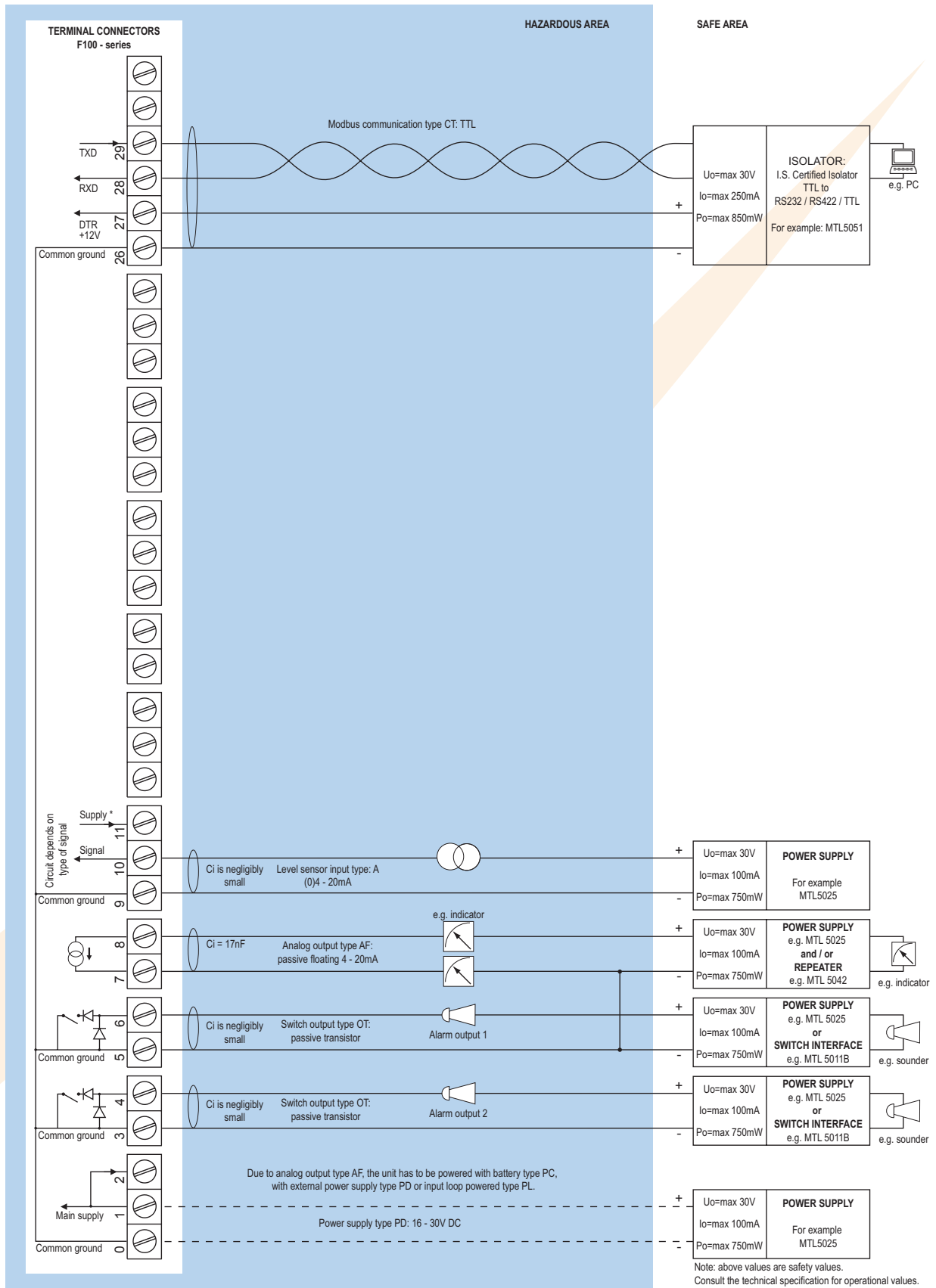

* Note power supply type PD: the supply voltage to the analog sensor is as connected to terminal 1 (internally linked).

Technical specification

General

Display	
Type	High intensity reflective numeric and alphanumeric LCD, UV-resistant.
Dimensions	90 x 40mm (3.5" x 1.6").
Digits	Seven 17mm (0.67") and eleven 8mm (0.31") digits. Various symbols and measuring units.
Refresh rate	User definable: 8 times/sec. - 30 secs.
Option ZB	Transflective LCD with green LED backlight. Good readings in full sunlight and darkness.
Note ZB	Only available for safe area applications.

Operating temperature

Operational	-30°C to +80°C (-22°F to +178°F).
Intrinsically Safe	-30°C to +70°C (-22°F to +158°F).

Power requirements

Type PB	Long life Lithium battery - life-time depends upon settings and configuration - up to 5 years.
Type PC	Intrinsically Safe long life lithium battery - life-time depends upon settings and configuration - up to 5 years.
Type PD	8 - 24V AC / DC ± 10%. Power consumption max. 10 Watt. Intrinsically Safe: 16 - 30V DC; power consumption max. 0.75 Watt.
Type PF	24V AC / DC ± 10%. Power consumption max. 15 Watt.
Type PL	Input loop powered from sensor signal 4 - 20mA (type "A") - requires types AI or AF and OT.
Type PM	115 - 230V AC ± 10%. Power consumption max. 15 Watt.
Type PX	8 - 30V DC. Power consumption max. 0.5 Watt.
Type ZB	12 - 24V DC ± 10% or type PD / PF / PM. Power consumption max. 1 Watt.
Note PB/PF/PM	Not available Intrinsically Safe.
Note PF/PM	The total consumption of the sensors and outputs may not exceed 400mA @ 24V.
Note	For Intrinsically Safe applications, consult the safety values in the certificate.

Sensor excitation

Type PB/PC/PX	3.2V DC.
Note	This is not a real sensor supply. Only suitable for sensors with a very low power consumption.
Type PD	3.2 / 8.2 / 12 / 24V DC - max. 50mA @ 24V DC.
Type PD-XI	The sensor supply volage is according to power supply as connected to terminal 1 (internally linked).
Type PF / PM	3.2 / 8.2 / 12 / 24V DC - max. 400mA @ 24V DC.

Terminal connections

Type	Removable plug-in terminal strip. Wire max. 1.5mm ² and 2.5mm ² .
------	---



Data protection

Type	EEPROM backup of all settings. Data retention at least 10 years.
Pass-code	Configuration settings can be pass-code protected.

Environment

Electromagnetic compatibility	Compliant ref: EN 61326 (1997), EN 61010-1 (1993).
-------------------------------	--

Hazardous area

Intrinsically Safe	ATEX approval ref.:  II 1 GD EEx ia IIB/IIC T4 T100°C.
Type XI	Maximum ambient +70°C (158°F).
Explosion proof	ATEX approval ref.:  II 2 GD EEx d IIB T5.
Type XF	Dimensions of enclosure: 300 x 250 x 200mm (11.8" x 9.9" x 7.9") L x H x D.
Weight	appr. 15 Kg.

Casing

General

Window	Polycarbonate window.
Sealing	Silicone.
Control keys	Three industrial micro-switch keys. UV-resistant silicone keypad.

Aluminum wall / field mount enclosures

General	Die-cast aluminum wall/field mount enclosure IP67 / NEMA 4X with 2-component UV-resistant coating.
Dimensions	130 x 120 x 75mm (5.12" x 4.72" x 2.95") - W x H x D.
Weight	1100 gr.
Type HA	Cable entry: 2 x PG9 and 1 x M20.
Type HM	Cable entry: 2 x M16 and 1 x M20.
Type HN	Cable entry: 1 x M20.
Type HO	Cable entry: 2 x M20.
Type HP	Cable entry: 6 x M12.
Type HT	Cable entry: 1 x 1/2" NPT.
Type HU	Cable entry: 3 x 1/2" NPT.
Type HZ	Cable entry: no holes.

GRP wall / field mount enclosures

General	GRP wall/field mount enclosure IP67 / NEMA 4X, UV-resistant and flame retardant.
Dimensions	130 x 120 x 75mm (5.12" x 4.72" x 2.95") - W x H x D.
Weight	600 gr.
Type HD	Cable entry: no holes.
Type HE	Cable entry: 2 x Ø 16mm and 1 x Ø 20mm.
Type HF	Cable entry: 1 x Ø 22mm (7/8").
Type HG	Cable entry: 2 x Ø 20mm.
Type HH	Cable entry: 6 x Ø 12mm.
Type HJ	Cable entry: 3 x Ø 22mm (7/8").
Type HK	Flat bottom, cable entry: no holes.

Panel mount enclosures

Dimensions	130 x 120 x 60mm (5.12" x 4.72" x 2.36") - W x H x D.
Panel cut-out	115 x 98mm (4.53" x 3.86") L x H.
Type HB	Die-cast aluminum panel mount enclosure IP65 / NEMA 4.
Weight	600 gr.
Type HC	GRP panel mount enclosure IP65 / NEMA 4, UV-resistant and flame retardant.
Weight	450 gr.

ABS wall / field mount enclosures

General	Silicone free ABS wall/field mount enclosure IP65 with EPDM and PE sealings. UV-resisitant polyester keypad (old HD enclosure).
Dimensions	130 x 114 x 71mm (5.1" x 4.5" x 2.8") - W x H x D.
Weight	450 gr.
Type HS	Cable entry: no holes.

Signal inputs

Level sensor	
Type A	(0)4 - 20mA. Analog input signal can be scaled to any desired range within 0 - 20mA.
Type U	0 - 10V DC. Analog input signal can be scaled to any desired range within 0 - 10V DC.
Accuracy	Resolution: 14 bit. Error < 0.025mA / ± 0.125% FS. Low level cut-off programmable.
Span	0.000010 - 9,999,999 with variable decimal position.
Offset	-999,999 - +999,999 units.
Update time	Four times per second.
Voltage drop	Type A: 2.5V @ 20mA.
Load impedance	Type U: 3kΩ.
Relationship	Linear calculation.
Note	For signal type A and U: external power to sensor is required; e.g. type PD.

Signal outputs

Analog output	
Function	Transmitting linearised level.
Accuracy	10 bit. Error < 0.05%. Analog output signal can be scaled to any desired range.
Update time	Ten times per second.
Type AA	Active 4 - 20mA output (requires OA + PD, PF or PM).
Type AB	Active 0 - 20mA output (requires OA + PD, PF or PM).
Type AF	Passive floating 4 - 20mA output for Intrinsically Safe applications (requires PC, PD or PL).
Type AI	Passive galvanically isolated 4 - 20mA output - also available for battery powered models (requires PB, PD, PF, PL or PM).
Type AP	passive 4 - 20mA output - not isolated. Unit will be loop powered.
Type AU	Active 0 - 10V DC output (requires OA + PD, PF or PM).

Alarm outputs

Function	User defined: low, low-low, high, high-high or all alarms output.
Type OA	Three active 24V DC transistor outputs (PNP); max. 50mA per output (requires AA + PD, PF or PM).
Type OR	Two electro-mechanical relay outputs isolated (N.O.) - max. switch power 230V AC - 0.5A (requires PF or PM) and one transistor output OT or OA (OA in combination with AA only).
Type OS	Four electro-mechanical relay outputs - isolated; max. switch power 230V AC - 0.5A per relay (requires AP and PD with 24V AC / DC).
Type OT	Three passive transistor outputs (NPN) - not isolated. Max. 50V DC - 300mA per output.
Note	Intrinsically Safe applications: only two transistor outputs type OT available.

Communication option

Function	Reading display information, reading / writing all configuration settings.
Protocol	Modbus RTU.
Speed	1200 - 2400 - 4800 - 9600 baud.
Addressing	Maximum 255 addresses.
Type CB	RS232
Type CH	RS485 2-wire
Type CI	RS485 4-wire
Type CT	TTL Intrinsically Safe.

Operational

Operator functions

Displayed functions	<ul style="list-style-type: none"> • Level and percentage. • Low-low alarm value. • Low alarm value. • High alarm value. • High-high alarm value. • Alarm values can be set (or only displayed).
---------------------	--

Level

Digits	7 digits.
Units	L, m ³ , GAL, USGAL, KG, lb, bbl, no unit.
Decimals	0 - 1 - 2 or 3.
Offset	User defined quantity.

Percentage

Digits	4 digits.
Decimals	1.

Alarm values

Function	Four user defined alarm values to monitor the level.
Digits	7 digits.
Units	According to the settings for level.
Decimals	According to the settings for level.
Type of alarm	Low, high, low-low or high-high level alarm. Includes alarm ignore time and configurable alarm outputs.
Protection	The alarm values can be pass-code protected.

Accessories

Mounting accessories

ACFo2	Stainless steel wall mounting kit.
ACFo5	Stainless steel pipe mounting kit (worm gear clamps not included).
ACFo6	Two stainless steel worm gear clamps Ø 44 - 56mm.
ACFo7	Two stainless steel worm gear clamps Ø 58 - 75mm.
ACFo8	Two stainless steel worm gear clamps Ø 77 - 95mm.
ACFo9	Two stainless steel worm gear clamps Ø 106 - 138mm.
ACF10	Customized Grevopal tagplates for ACFo2 and ACFo5, including stainless steel screws. Dimension: 95mm x 12.5mm (3.75" x 0.50").

Cable gland accessories



ACF20	For HA enclosure, includes O-rings.
ACF25	For HE enclosure, includes locknuts and O-rings.
ACF26	For HF enclosure, includes locknuts and O-rings.
ACF27	For HG enclosure, includes locknuts and O-rings.
ACF28	For HH enclosure, includes locknuts and O-rings.
ACF29	For HJ enclosure, includes locknuts and O-rings.
ACF32	For HM enclosure, includes O-rings.
ACF33	For HN enclosure, includes O-rings.
ACF34	For HO enclosure, includes O-rings.
ACF35	For HP enclosure, includes O-rings.
ACF39	For HT enclosure, includes O-rings.
ACF40	For HU enclosure, includes O-rings.

Ordering information



Standard configuration: F173-A-AP-CX-EX-HC-IX-OT-PX-TX-XX-ZX.

Ordering information: F173 - -A - -C - -EX -H - -IX -O - -P - -TX -X - -Z -



Level input signal

- A  **(0)4 - 20mA input.**
- U  0 - 10V DC input.

Analog output signal

- AA Active 4 - 20mA output - requires OA + PD, PF or PM.
- AB Active 0 - 20mA output - requires OA + PD, PF or PM.
- AF  I.S. floating 4 - 20mA output - requires PC, PD or PL.
- AI Isolated 4 - 20mA output - requires PB, PD, PF, PL or PM.
- AP  **Passive 4 - 20mA output, loop powered unit.**
- AU Active 0 - 10V DC output - requires OA + PD, PF or PM.



Communication

- CB Communication RS232 - Modbus RTU.
- CH Communication RS485 - 2wire - Modbus RTU.
- CI Communication RS485 - 4 wire - Modbus RTU.
- CT  Intrinsically Safe TTL - Modbus RTU.
- CX  **No communication.**







Flow equations

- EX  **No flow equations.**









Panel mount enclosures - IP65 / NEMA4

- HB  Aluminum enclosure.
- HC  GRP enclosure.

GRP field / wall mount enclosures - IP67 / NEMA4X

- HD  Cable entry: no holes.
- HE  Cable entry: 2 x Ø 16mm & 1 x Ø 20mm.
- HF  Cable entry: 1 x Ø 22mm (7/8").
- HG  Cable entry: 2 x Ø 20mm.
- HH  Cable entry: 6 x Ø 12mm.
- HJ  Cable entry: 3 x Ø 22mm (7/8").
- HK  Flat bottom, cable entry: no holes.

Aluminum field / wall mount enclosures - IP67 / NEMA4X

- HA  Cable entry: 2 x PG9 + 1 x M20.
- HM  Cable entry: 2 x M16 + 1 x M20.
- HN  Cable entry: 1 x M20.
- HO  Cable entry: 2 x M20.
- HP  Cable entry: 6 x M12.
- HT  Cable entry: 1 x 1/2" NPT.
- HU  Cable entry: 3 x 1/2" NPT.
- HZ  Cable entry: no holes.

ABS field / wall mount enclosures

- HS  Silicone free ABS field enclosure IP65 – Cable entry: no holes (old HD enclosure).





Additional inputs

- IX  **No additional input.**

Outputs

- OA Three active transistor outputs - requires AA, AB or AU and PD, PF or PM.
- OR Two mechanical relay outputs + one OT or OA - requires PF or PM.
- OS Four mechanical relay outputs - requires AP and PD.
- OT  **Three passive transistor outputs - standard configuration.**

Power supply

- PB Lithium battery powered.
- PC  Lithium battery powered - Intrinsically Safe.
- PD  8 - 24V AC/DC + sensor supply - with XI: 16 - 30V DC.
- PF 24V AC/DC + sensor supply.
- PL  Input loop powered from sensor signal type "A" - requires AI or AF and OT.
- PM 115 - 230V AC + sensor supply.
- PX  **Basic power supply 8 - 30V DC (no real sensor supply). Unit requires external loop AP.**

Temperature input signal

- TX  **No temperature input signal.**

Hazardous area

- XI  Intrinsically Safe.
- XF EExd enclosure - 3 keys.
- XX **Safe area only.**

Other options

- ZB Backlight.
- ZX  **No options.**

The bold marked text contains the standard configuration.

 Available Intrinsically Safe.

Specifications are subject to change without notice.

FLUIDWELL bv
P.O. Box 6
5460 AA - Veghel - The Netherlands
Tel.: +31 (0)413 343786
Fax.: +31 (0)413 363443
sales@fluidwell.com
Internet: www.fluidwell.com

